

# Operating Handbook

# **METROTEC**

Systems for oxygen measurement

## **GSM**

Oxygen measurement and control unit

**Type GSM**

\*\*\* Version 2.2 \*\*\*

## EC Declaration of Conformity

for  
Oxygen measurement and control unit  
GSM

This device has been designed for industrial purposes in accordance with:

*EN 61000-6-4*  
*EN 61000-6-2*

It is compliant with the directives:

*EMC Directive: 2014/30/EU*  
*Low Voltage Directive: 2014/35/EU*  
*RoHs: 2011/65/EU*

This device complies with following standards:

*EN 61010-1*  
*EN 61000-6-4*  
*EN 61000-6-2*  
*EN 63000*

Description of measures taken to assure compliance:

*Quality management system DIN EN ISO 9001:2015, No. 12 100 27736 TMS*

This declaration becomes invalid if changes are made without  
our consent.



---

Kirchheim/Teck, 07/10/2019

Place, Date

Signature

## Contents

<b>1</b>	<b>SAFETY INSTRUCTIONS.....</b>	<b>4</b>	7.5	Alarm output .....	17
<b>2</b>	<b>PREFACE .....</b>	<b>5</b>	7.6	Control output.....	17
<b>3</b>	<b>INTRODUCTION .....</b>	<b>6</b>	7.7	Scaling of the trend graphs.....	18
3.1	Measurement principle .....	6	<b>8</b>	<b>OPTIONS .....</b>	<b>18</b>
3.2	Measurement electronics .....	7	8.1	Dew point .....	18
<b>4</b>	<b>GENERAL ARRANGEMENT .....</b>	<b>7</b>	8.2	Lambda .....	19
4.1	Description of the measurement electronics .....	7	8.3	CO.....	19
<b>5</b>	<b>PUTTING THE UNIT INTO OPERATION.....</b>	<b>8</b>	8.4	Calculated oxygen value .....	19
5.1	Mounting and connection of sensors	8	<b>9</b>	<b>INTERFACES .....</b>	<b>20</b>
5.2	Switching the unit on .....	8	9.1	Analogue interfaces .....	20
5.3	Switching off the measurement unit	8	9.2	Digital interfaces .....	20
<b>6</b>	<b>OPERATION.....</b>	<b>9</b>	9.2.1	<i>Standard interfaces.....</i>	<i>20</i>
<b>7</b>	<b>CONFIGURATION.....</b>	<b>13</b>	9.2.2	<i>Optional interface: RS 485..</i>	<i>20</i>
7.1	Enablement of Configuration .	13	9.2.3	<i>Optionale interface: Ethernet</i>	<i>24</i>
7.2	Displayed values .....	14	<b>10</b>	<b>SPECIAL FEATURES.....</b>	<b>25</b>
7.3	Process parameters.....	15	10.1	Correction factors .....	25
7.4	mA outputs .....	15	10.2	Filter factor.....	26
			10.3	Oxygen controller .....	26
			10.4	Coding.....	27
			10.5	Function of the clock .....	27
			10.6	Connection plan.....	28
			<b>11</b>	<b>TECHNICAL DATA.....</b>	<b>29</b>

## 1 Safety instructions



Please read through this operating manual very carefully before installing and commissioning the unit.  
Incorrect utilisation will invalidate the guarantee!



Correct functioning and the operating safety of the unit can only be guaranteed if the ambient conditions specified in the Specifications chapter are maintained.



Only qualified specialists are permitted to commission and operate the unit. The owner of the unit must ensure that the installation complies with the relevant laws and directives. These include, for example, the EU Directives covering safety in the workplace, national safety in the workplace regulations and the prevention of accidents regulations, etc.



You must ensure that the power supplies concur with the details listed on the nameplate. All of the covers needed to ensure that the unit cannot be touched when operating must always be fitted. You must consider the effects of the overall operation and take the necessary precautions if the unit will be linked up with other equipment and/or devices before you switch on.



Parts and surfaces will occasionally become and remain hot during the installation or de-installation. Suitable precautions must be taken in order to prevent injuries or damage to the unit from occurring.



If the unit shows signs of having been damaged and you are of the opinion that that safe operation is no longer possible then you must not run the unit. We recommend that periodical inspections are carried out at our factory or by our customer service department at least once a year.



Future disposal must always comply with the legal regulations.

## 2 Preface

With the aid of an oxygen sensor, the measurement unit serves to measure the oxygen partial pressure in gaseous atmospheres. Such sensors work at high temperatures and so it is necessary for measures to be taken to ensure that no flammable gas mixtures contact the sensor or the unit. In the event of the sensor ceramic suffering breakage the measurement gas could escape or air could enter the measurement gas side of the unit and so suitable measures have to be taken to avoid such an event leading to environmental pollution or damage being done to equipment.

**In the event of incorrect parameters being set or the occurrence of leakage, corrosion, condensation, etc., damage could be done to the equipment and incorrect measurement results be indicated and so it is essential that all parts of equipment be regularly serviced.**

*The oxygen sensor and its accessories are subjected to thorough quality control in accordance with DIN ISO 9001 in the course of their manufacture and testing.*

*They must only be installed and used in compliance with all applicable local and special regulations, particularly the VDE and DVGW standards that apply in Germany.*

*The measurement accuracy and effective function of the measurement device will need to be checked at intervals whose frequency will depend on the application concerned. Such a check must be effected in the course of a calibration and examination check on the equipment being first put into operation.*

### 3 Introduction

#### 3.1 Measurement principle

Oxygen measurement units are designed to process signals transmitted from an oxygen sensor constructed of stabilised zirconium oxide. Zirconium oxide, a ceramic material that is also spoken of as a solid-state electrolyte, acts as an excellent oxygen-ion conductor when at a high temperature.

Within certain temperature limits, that depend on the doping of the material concerned, such ion conductors are able to fill empty spaces in their crystal lattice with oxygen ions. The oxygen ions occur against an electrically conductive surface that is generally of platinum.

The concentration of oxygen in a measurement gas is thus decisive for the extent of oxygen activity, and thus for the number of oxygen ions.

An oxygen sensor consists essentially of a solid-state electrolyte with a contact surface on both sides.

One side of the electrolyte is in contact with a reference gas such as air, and the other with the gas whose oxygen content is to be measured. The mechanical construction of the sensor prevents contact between the two gases so that there is no risk of their being intermixed.

Depending on the application concerned, heated or unheated sensors are used. Unheated sensors are generally used in furnaces while heated sensors are used for applications where the gas to be measured is at a temperature of less than around 600 degrees Celsius (the measurement principle necessitates the sensor being maintained at a temperature of not less than 500 - 650 degrees Celsius).

Heated sensors are maintained at a set temperature by an electronic temperature regulator that forms part of the electronic control unit. The temperature of both heated and unheated sensors as measured by the electronic control is an important parameter for inclusion in the calculation of the oxygen content (oxygen partial pressure) in accordance with the following equation:

$$EMF = \frac{R \cdot T}{4 \cdot F} \cdot \ln\left(\frac{P_1}{P_2}\right)$$

whereby:

R = 8.31J/mol K

T = Temperature in Kelvin

F = 96493 As/mol

P<sub>1</sub> = Oxygen partial pressure on the reference side with 0.20946 bar

P<sub>2</sub> = Oxygen partial pressure on the measurement gas side

EMF = Electromotive force in Volts

### 3.2 Measurement electronics

The electronic circuit of the measurement unit Type GSM provides the following functions:

Measurement of the oxygen partial pressure

Maintaining the oxygen content at a present level

Generating alarm signals

Option: Calculation of the dew point

Option: Calculation of the air factor lambda point

The device is operated with the aid of a keypad.

Menus assist the operator in the selection of inputs and outputs and in the setting of parameters.

## 4 General arrangement

### 4.1 Description of the measurement electronics

The elements at the front of the unit are in three groups

**Keypad:**

The keypad has four keys by means of which all the necessary functions can be effected.

**Display:**

The graphic display provides for the display of measured values, data, time graphs and messages.

## **5 Putting the unit into operation**

### **5.1 Mounting and connection of sensors**

Read separate instructions.

### **5.2 Switching the unit on**

Once all electrical connections have been made and checked, the power plug is plugged in. After waiting for about 15 minutes for the sensor to be heated up, the unit indicates the oxygen content of the gas concerned. but stable values are only indicated about fifteen minutes after the heating-up period has expired.

### **5.3 Switching off the measurement unit**

It is preferable for the unit to be kept in continuous operation. As the sensor then remains heated there is less risk of it suffering the presence of condensation. that could lead to corrosion but if it is required to put the unit out of operation, the power plug should be withdrawn and attention be paid to the following points:

#### **Heated sensors:**

##### *Inline sensors:*

Remove carefully while still hot and allow to cool, taking care to avoid mechanical or thermal stress!

##### *Compact sensors:*

Flush with air before switching off

#### **Unheated sensors:**

These are generally left in place

#### **Putting the measurement unit briefly out of operation:**

When the unit is switched on again after being switched off for a short time, the instructions given above under "Switching the unit on" should be followed.



## 6 Operation

A few seconds after switching on, the first page is displayed as follows:

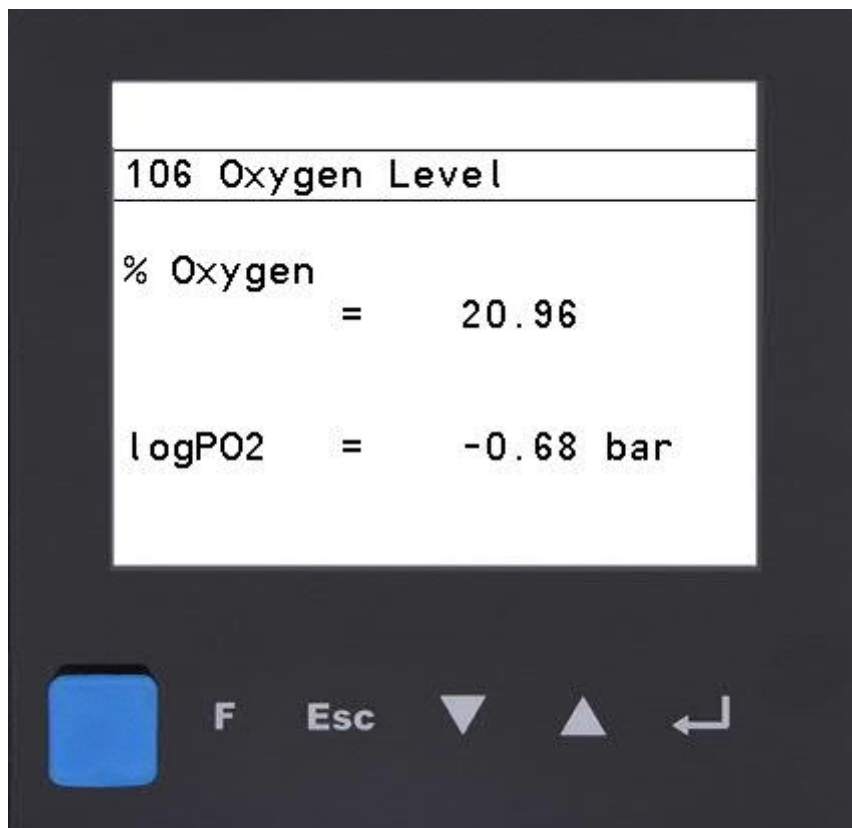

Each page has a headline that is separated by a line from the rest of the display. This headline indicates the page number and the title or an outstanding fault message. Beneath the line there is either a graph or a 6-line text.

The keypad has five components.

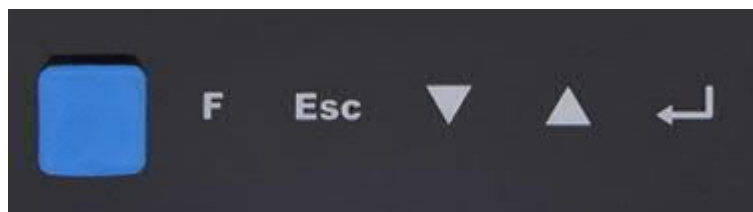

⇒ On the extreme left there is a rubber cap that is only removed to allow access to the socket beneath to which the communication cable is connected when it is required to install a new program.

⇒ The adjacent key provides for switching between manual and automatic operation.

- ⇒ The two arrow keys provide for moving the cursor line upwards or downwards or for increasing or decreasing values when alterations to entry fields are enabled.
- ⇒ The key on the right provides for
  - a) Opening a display page
  - b) Opening an entry field to enable an entry to be made
  - c) Closing an entry field and storing an entry.
- ⇒ The “Esc” key is for closing the display page or return to overview

Pressing the right-hand key causes the display to jump to the page selection list and then the cursor bar can be moved to the line bearing the required page title. When this no longer illuminated page title is confirmed by pressing the right-hand key, the page concerned is displayed.

An opened page can be closed again by pressing the right-hand key.

A window opens for any inputs. Like below example values can be stored by pressing the buttons. „Min“ and „max“ shows the limit values. „Cu“ shows the current value. Store by pressing „OK“.



The various pages that can be selected in normal operation are detailed below.

107 P-Variables		
EMF	=	250 mV
Temp	=	700 Grad C
logO2	=	-5.47 bar
Dewp.	=	100 Grad C
Lambda	=	1.00
O2 red	=	9999 ppm

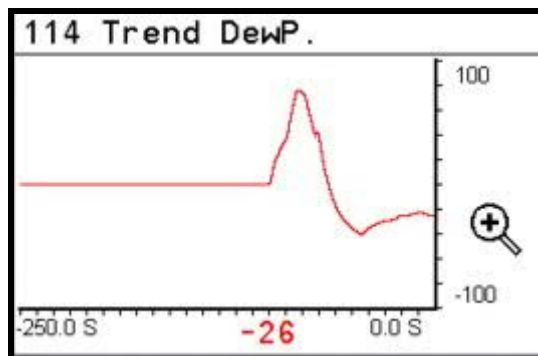
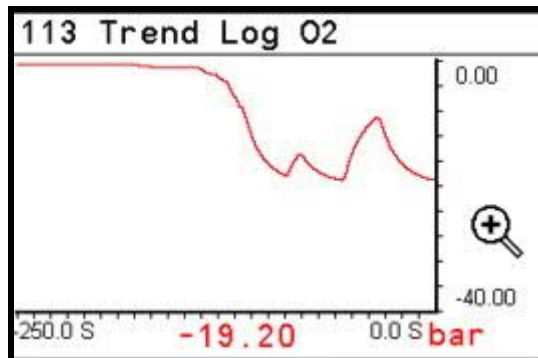
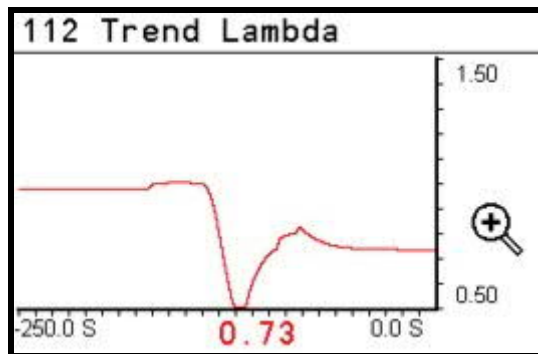

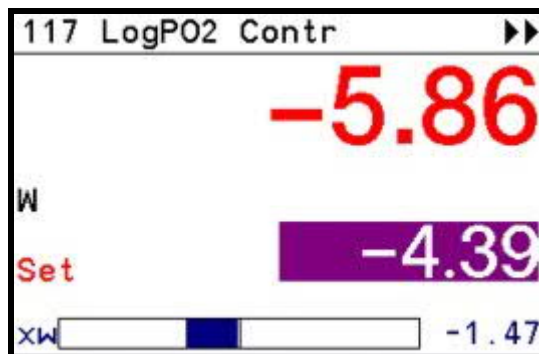
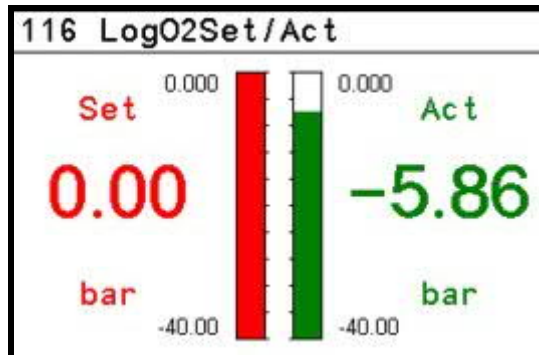
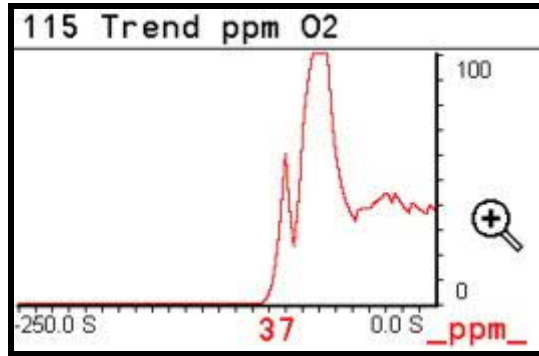

## 7 Configuration

### 7.1 Enablement of Configuration

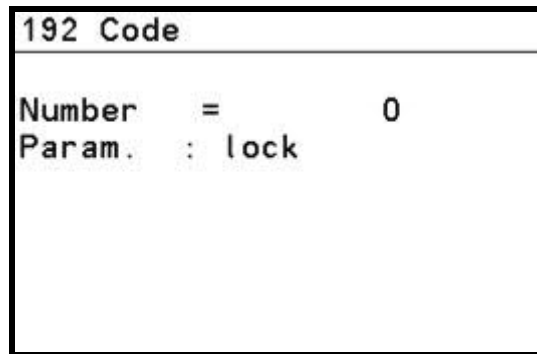

*Before parameters can be altered it is first necessary to overcome the disablement code. Only then is access to additional pages possible. Enablement is effected as follows:*

1. Select the page entitled CODE in the page selection table.
2. Press the key on the extreme right.
3. Keep pressing an arrow key until the NUMBER line is no longer backlighted.
4. Press the right-hand key. A input mask will open.



5. Press the right-hand key Press the right-hand key until your specific code (which was "1" on delivers) is displayed.
6. Once the required code is displayed, press the right-hand key once more to confirm the entry. The message "Parameters free" appears in the next line.

192 Code		
Number	=	0
Param.	:	free

You then have access to the page selection list once more.

Operating pages		
106	Oxygen Level	
107	P-Variables	
112	Trend Lambda	
113	Trend Log O2	
114	Trend DewP.	
115	Trend ppm O2	
116	LogO2Set/Act	
117	LogPO2 Contr	

**Note:**

*Access to parameters and configurations is enabled for only a limited period. (90 seconds) If more time is needed, then it will be necessary to repeat the steps needed to overcome the disablement code.*

## 7.2 Displayed values

119 Corrections		
EMF +	=	0.00
EMF *	=	1.00
H2 Part.	=	0.10 %
GasF.	=	1.087
LOG	=	-5.86 corr
O2	=	1.38 corr

For the calculation of lambda and dew point it is necessary to enter characteristic values as also detailed under "Options".

Here you can adjust the measured value with an set point value of a test gas by varying “EMF+” or “EMF\*”. The result is displayed under “LOG” and “O2”

The value 0.00 for the additive correction and of 1.0 for the multiplicative correction means that no correction is to be applied to the determined EMF value.

### 7.3 Process parameters

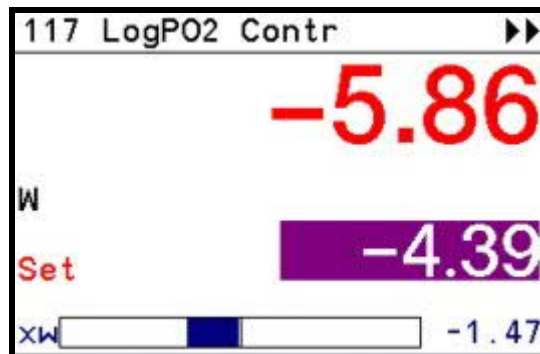

This page is selected from the page list as described above. The unlighted cursor beam can be positioned against the required value by means of the arrow keys. The cursor beam is then positioned against the value concerned and the entry is confirmed by pressing the right-hand key. The displayed value can be increased or decreased to cause the new required value to be displayed. Once this is achieved, it is confirmed by pressing the right-hand key and the new value is thus stored in the memory.

163 Contr. -Param		
Xp1	=	900.0
Xp2	=	900.0
Tn	=	3.0
Tv	=	0.0
Filter	=	11.0

Filter = 0.0 means that no filter is active. Fluctuations in the sensor signal can be attenuated with the aid of a filter factor.

### 7.4 mA outputs

The device has three analogue outputs. Output 1 is for the logarithmic oxygen value, Output 2 for the linear oxygen value and Output 3 for various optional values such as dew point or lambda: values for outputs 1 and 2 are thus displayed on one page and those for Output 3 on a separate page.

118 Out LIN/LOG	
LINmax	= -3.00
LOGmax	= 0.00
LOGmin	= -6.00
....Output mA...	
= 4-20mA	

The significance of LINmax values:

0,00	$10^0$	1	100%
-1,00	$10^{-1}$	0,1	10%
-2,00	$10^{-2}$	0,01	1%
-3,00	$10^{-3}$	0,001	0,1% = 1000 ppm
-4,00	$10^{-4}$	0,0001	0,01% = 100 ppm
-5,00	$10^{-5}$	0,00001	0,001% = 10 ppm

It should be borne in mind that linear values always extend from 0 to LINmax and that with logarithmic values the LOGmax value must always be greater than LOGmin.

169 Scal. Out 3	
W: 0=L; 1=CO; 2=TP	
3=O2B	
W:	= 2 Active
Part% of 0-100	
up	= 100 20 mA
down	= 0 0/4 mA

A choice has to be made between four possibilities. The figure "W" has to be set accordingly. End values have also to be set for 0 and for 20 mA. This is done by defining an end point within the total physical range for 0 – 100 parts indicated in the table below, within which a window for UPPER and LOWER limits can be established.

Lambda	0 to 100
CO	0 to 10%
Dew point	-100 to 100 degrees
O2B	0 to 1000 ppm



## 7.5 Alarm output

128 Alarm Limits			
Limit Temp			
Max	=	800	Grad C
Min	=	500	Grad C
Limit logPO2			
Max	=	0.00	bar
Min	=	-30.00	bar

The definition of Alarm is self evident.

It has also to be defined whether the physical output is to be a relay or a semiconductor.

180 Lockout			
Code	=	1	New
Code	=	0	I/O
Code	=	0	Konf.
Code	=	0	Comm.
Alarm is a			
Relay			

## 7.6 Control output

It has also to be defined whether the physical control output is to be a relay or a semiconductor. If the alarm output is a relay then the control output is a semiconductor and if the alarm output is a semiconductor, then the control output is a relay.

180 Lockout			
Code	=	1	New
Code	=	0	I/O
Code	=	0	Konf.
Code	=	0	Comm.
Alarm is a			
Relay			

## 7.7 Scaling of the trend graphs

The scaling of the graphs cannot be altered. Alterations to the axes can only be effected by the supplier.

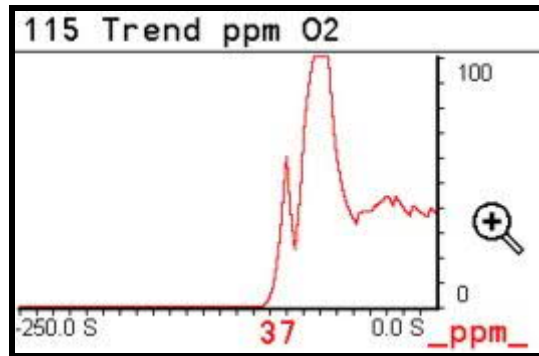

**Exception:** The Y-axis will be enlarged 4 times if „+“ will be pressed. Pressing „-“, the original scale is active again.

## 8 Options

### 8.1 Dew point

For some applications it is required that the dew point in degrees Celsius be calculated. This is frequently the case where nitrogen/hydrogen mixtures are concerned. The dew point is determined by comparing the measured O<sub>2</sub>- value with that of a standard hydrogen percentage who's value has to be entered under "Parameters".

Note:

*Calculation of dew point is a mathematical function. If there is a change in the hydrogen percentage or if no hydrogen is present, then the dew point cannot be calculated correctly*

119 Corrections		
EMF +	=	0.00
EMF *	=	1.00
H2 Part.	=	0.10 %
GasF.	=	1.087
LOG	=	-5.86 corr
O2	=	1.38 corr

## 8.2 Lambda

For some applications it is of importance to know the lambda value of a combustion gas or of a gas/air mixture. In this case, lambda is defined as follows:

$$\text{Lambda} = (\text{combustion air supplied}) / (\text{combustion air theoretically required})$$

If this feature is required, it is necessary for a characteristic value to be entered in the "Parameter" menu.

Note:

*Calculation of dew point is a mathematical function. If the C/H value changes or is not present, then the lambda value can no longer be calculated correctly*

119 Corrections			
EMF +	=	0.00	
EMF *	=	1.00	
H2 Part.	=	0.10	%
GasF.	=	1.087	
LOG	=	-5.86	corr
O2	=	1.38	corr

## 8.3 CO

The CO value is derived from the lambda function. (see note under lambda)

## 8.4 Calculated oxygen value

The calculated oxygen value "O2B" of a nitrogen/hydrogen mixture is determined from the hydrogen percentage (see under "Dew point" option)

## 9 Interfaces

### 9.1 Analogue interfaces

The device has three 0 – 20 mA analogue interfaces all of which can be active at the same time. A change to 4 – 20 mA can be effected by the user.

118 Out LIN/LOG	
LINmax	= -3.00
LOGmax	= 0.00
LOGmin	= -6.00
....Output mA...	
= 4-20mA	

### 9.2 Digital interfaces

#### 9.2.1 Standard interfaces

There are two relays, either of which can be defined as either a control output or as an alarm output. There are also two semiconductor outputs which can be defined as an alarm or as a control output.

180 Lockout	
Code	= 1 New
Code	= 0 I/O
Code	= 0 Konf.
Code	= 0 Comm.
Alarm is a	
Relay	

#### 9.2.2 Optional interface: RS 485

The interface plug is at rear site between the connector block

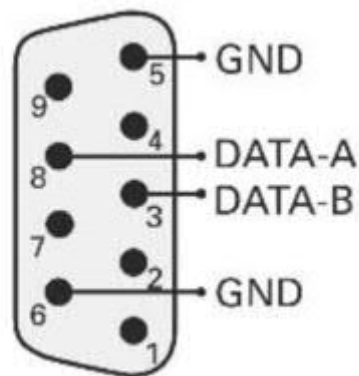

180 Lockout		
Code	=	1 New
Code	=	0 I/O
Code	=	0 Konf.
Code	=	0 Comm.
Alarm is a Relay		

To define the interface it first must be entered at "Lockout" the code 5 in line "Comm". Then skip to the definition-page with 2 times pressing the "Esc" button. Following the interface-parameters like type, address and baurate can be defined.

Main menu
Operating pages
Parameter
Signals
Configuration
<b>Device settings</b>

Device settings
Date, time
<b>Device data</b>
Online/Offline
Calibration
Info
Status I/O
Status CAN-Bus

Device data	
Protoc =	ISO 1745
Baud =	4800
Addr. =	1
Frequ. =	50 Hz
Langu. =	english
CAN-Id =	(NMT) 1
CAN-Bd =	20kBit
Freeze =	off

Data request at protocol ISO 1745, 7bit, 1 Stopbit, Even, for the example address 1 is:  
Whereat: Ad r = address, C3 ...C6 und C1 are invariable,

Value for C2	
3	= % O <sub>2</sub>
4	= Log O <sub>2</sub>
5	= ppm O <sub>2</sub>
6	= Tp
7	= O <sub>2</sub> red
8	= Temperature
9	= Alarm

Whereat alert 1 = faultless, 2 = collective message, 3 = range overstepping 4 = collective message and range overstepping

EOT	Adr	Adr	C1	C2	,	C3	C4	C5	,	C6	ENQ	
EOT	0	1	0	0	,	0	0	1	,	0	ENQ	
04	30	31	30	33	2C	30	30	31	2C	30	05	

Response

STX	C1	C2+1	=	Wert	EOT
STX	0	1	=	Wert	EOT
04	30	34	3D	HEX-Wert	05

Data request at protocol Modbus RTU, 8bit, 1 Stopbit, Even

Device data	
Protoc =	Modbus
Baud =	19200
Addr. =	1
Frequ. =	50 Hz
Langu. =	english
CAN-Id =	(NMT) 1
CAN-Bd =	20kBit
Freeze =	off

Adress	Function	Storage adress		Registers		CRC 1	CRC 2
		Byte1	Byte2	Byte1	Byte2	Byte	Byte
	03						

Excmple for a request at address 1 in HEX-display

Measurement value								
% O <sub>2</sub>	01	03	80	A4	00	02	AC	2B
log O <sub>2</sub>	01	03	80	A6	00	02	0D	E8
ppm O <sub>2</sub>	01	03	80	A8	00	02	6C	2B
TP	01	03	80	AA	00	02	CD	EB
O <sub>2</sub> red	01	03	80	AC	00	02	2D	EA
Temperature	01	03	80	AE	00	02	8C	2A
Alarm	01	03	80	B0	00	02	EC	2C

All values	01	03	80	A4	00	0E	AC	2D
------------	----	----	----	----	----	----	----	----

Excmple for the request:

Temperature	01	03	80	AE	00	02	8C	2A
-------------	----	----	----	----	----	----	----	----

Excmple-answer = 1760,00

Temperature	01	03	04	44	DC	00	00	2F	39
			4Byte	Byte1	Byte2	Byte3	Byte4		

### 9.2.3 Optionale interface: Ethernet

The interface plug is at rear site between the connector block.  
Connection to network is done by standard cables.

180 Lockout		
Code	=	1 New
Code	=	0 I/O
Code	=	0 Konf.
Code	=	0 Comm.
Alarm is a Relay		

To define the interface it first must be entered at "Lockout" the code 5 in line "Comm". Then skip to the definition-page with 2 times pressing the "Esc" button. Following the interface-parameters like type, address can be defined.

Main menu
Operating pages
Parameter
Signals
Configuration
<b>Device settings</b>

Device settings
Date, time
<b>Device data</b>
Online/Offline
Calibration
Info
Status I/O
Status CAN-Bus



```

Device data
Frequ. =          50 Hz
Langu. =          english
CAN-Id =          (NMT) 1
CAN-Bd =          20kBit
Freeze =          off
Delay =          0
Ethernet

```

```

IP-Addr = 192.168.000.051
Subnet  = 255.255.255.000
Gateway = 192.168.000.001
DHCP    = off
MAC-Adr = 00-0F-67-0F-4C-8C
Loc host= KS98-2_0F-4C-8C

```

Input for IP-address und Subnet.

The data protocol is similar Modbus protocol which is explained above

Modbus RTU Message						
			Slave ID	FCode	Data	CRC
Modbus TCP/IP						
Header				Modbus TCP/IP Message		
Transaction ID	Protocol ID	Length	Unit ID	FCode	Data	
Example						
0005	0000	0006	01	010380A4	000E	-----

## 10 Special features

### 10.1 Correction factors

There is one additive and one multiplicative correction factor. These can be applied as a correction to the EMF value determined by the sensor and thus to the measured value that is displayed. It may be necessary to amend these factors in the course of calibration. The necessary entry is detailed under "Configuration".

119 Corrections		
EMF +	=	0.00
EMF *	=	1.00
H2 Part.	=	0.10 %
GasF.	=	1.087
LOG	=	-5.86 corr
O2	=	1.38 corr

## 10.2 Filter factor

If there is excessive fluctuation in the measured values, it is possible to apply an attenuation factor of between 0 and 200. This attenuation factor has an integration effect on the oxygen value. The necessary entry is detailed under "Configuration Process parameters".

163 Contr. -Param		
Xp1	=	900.0
Xp2	=	900.0
Tn	=	3.0
Tv	=	0.0
Filter	=	11.0

## 10.3 Oxygen controller

The required value is entered as the logarithmic oxygen partial pressure  
The necessary entry is detailed under "Configuration Process parameters".

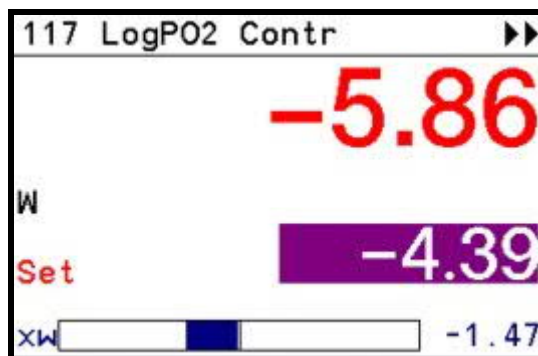

## 10.4 Coding

To prevent unauthorised amendment of important entries, the pages concerned are only displayed once an access code has been entered (see under "Enablement of configuration")  
On this page there is provision for programming a new access code.

Caution:

*Not even the supplier can decipher an access code that has been forgotten.*

**THE PROBLEM CAN ONLY BE SOLVED BY ENTERING COMPLETELY NEW SOFTWARE:**

```
180 Lockout
-----
Code      =      1 New
Code      =      0 I/O
Code      =      0 Konf.
Code      =      0 Comm.
Alarm is a
Relay
```

## 10.5 Function of the clock

First line displays the time. The time hasn't any function inside of the program. If the time should be adjusted it should be done like described for the interface

```
Device settings
-----
Date, time
Device data
-----
Online/Offline
Calibration
Info
Status I/O
Status CAN-Bus
```

10.6 Connection plan

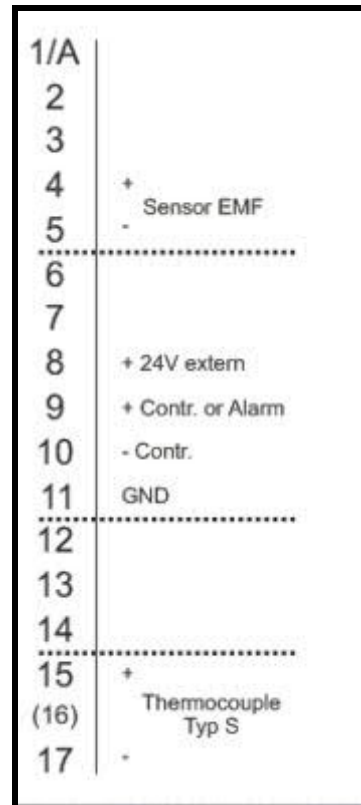
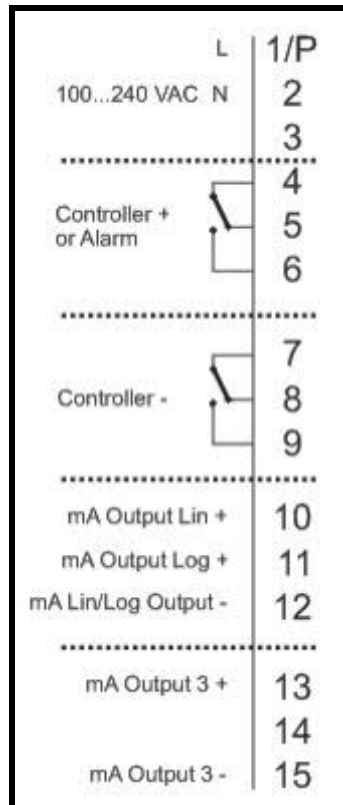

## 11 Technical data

Measurement range	100 % to $10^{-31}$ bar O <sub>2</sub>
Ambient temperature	0 to 45 degrees Celsius
Measurement accuracy	+/- 0.3 mV of the sensor EMF +/- 2 degrees Celsius +/- 2% of the mA output +/- 2% of the log oxygen partial pressure
Temperature input	Thermocouple Type S
Heating-up time for sensors	10 to 15 minutes
Response time	approx 2 seconds
Contact load capacity	2A, 24 V (ohmic)
Dimensions	96 x 96 x 160 mm (HxWxD)
Cutout	92 x 92 mm
Electromagnetic compatibility	The equipment meets the requirements of European directive 89/336EWG and complies with the following standards: Interference transmission EN 50081-1 Immunity from interference EN 50082-2 The device can be used without restriction in residential and industrial surroundings.
Power supply	100-240 Volt AC
Front protection (mounted)	IP 65